

LTE 4G Bands Flexible PCB Antenna

SPECIFICATION



P/N: FPC-00LAI1A

Antenna Features

Electrical

LTE (LB+MB+HB)

Environmental

Dim: 67.4mm*58.4mm*0.13mm

-50°C~85°C Thermal Resistance

RoHS, REACH Compliant

Installation

Double Sided Adhesive

Direct Stick on Device Enclosure

Application

4G LTE Communications

Remote Monitoring

Internet Applications



Content

1.	Introduction.....	3
2.	Specification	4
3.	Antenna Characteristics.....	5
3.1.	LTE 4G Bands Antenna	6
3.1.1.	Return Loss	6
3.1.2.	Efficiency	6
3.1.3.	Peak Gain	6
3.1.4.	Antenna Measurement Setup & 3D Patterns	7
4.	Drawing	9
5.	Packaging.....	10
6.	Application Note	12



NOVOCOMMS

1. Introduction

Flexible PCB Antenna Series

P/N: FPC-00LAI1A

NVC provides high quality FPCB LTE series for 4G applications. The flexible PCB antennas including cable and connector, can be easily installed on the housing surfaces by adhesive. By just simple "Peel and Attach", it will assist end users to get seamless 4G connections.

Such application, for example, a video conference call, remote monitoring and internet applications, the mobile devices require a reliable data connection whether it is indoor or outdoor. NVC FPCB LTE antennas offer high quality 4G LTE connections at a competitive price when "Wifi" sometimes is not an available choice.

NVC provides different scenario options to be selected, please read the technical specifications to choose the best suitable solution for you. Or, Even better, we can customize the antenna completely based on your requirements. Please contact local sales for more info and support.



NOVOCOMMS

2. Specification

Flexible PCB Antenna Series

P/N: FPC-00LAI1A

LTE 4G bands			
Band	LB	MB	HB
Frequency (MHz)	698~960	1710~2700	3400~3800
Technical Spec			
Peak Gain (dBi) *	0.76	3.89	3.6
Efficiency (%)*	>30	>56	>64
Polarization	Linear Polarization		
Impedance	50Ω		
MECHANICAL			
Dimension	67.4mm*58.4mm*0.13mm		
Material Content	Flexible PCB		
Coaxial Cable	φ 1.37mm Micro Coax., 56.66mm length, Fully Customizable		
Connector	IPEX MHFI		
Adhesive	3M467		
Weight	9.5g/1pcs		
Pulling Force	Minimum 2 KGF/cm2		
ENVIRONMENTAL			
Operation Temperature	-40°C to 85°C		
Storage Temperature	-40°C to 90°C		
Humidity	Non-condensing 65°C 95% RH		

*The antenna was tested on 2mm thick ABS board.



NOVOCOMMS

Flexible PCB Antenna Series

P/N: FPC-00LAI1A

3. Antenna Characteristics

3.1. LTE 4G Bands Antenna

3.1.1. Return Loss



3.1.2. Efficiency

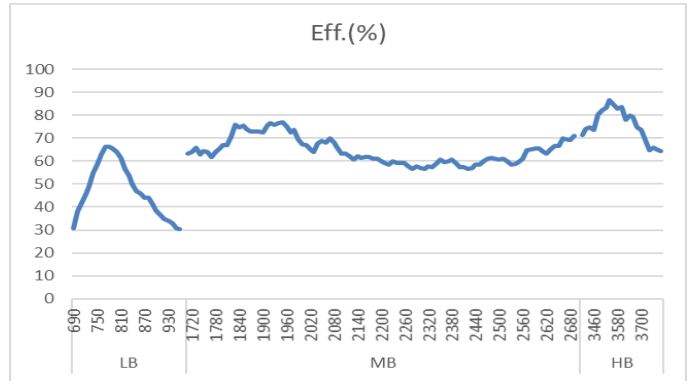

3.1.3. Peak Gain

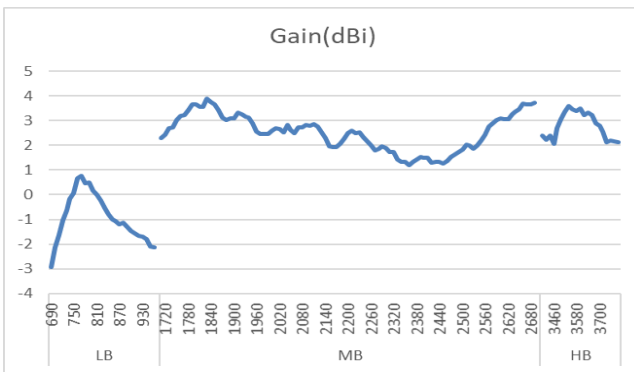



NOVOCOMMS

Flexible PCB Antenna Series

P/N: FPC-00LAI1A

3.1.4. Antenna Measurement Setup & 3D Patterns

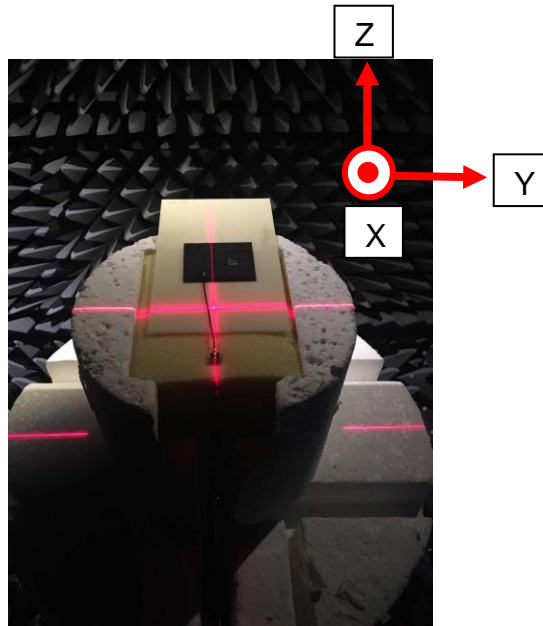

*Testing set in NVC GTS2800 compatible Anechoic Chamber

880MHZ

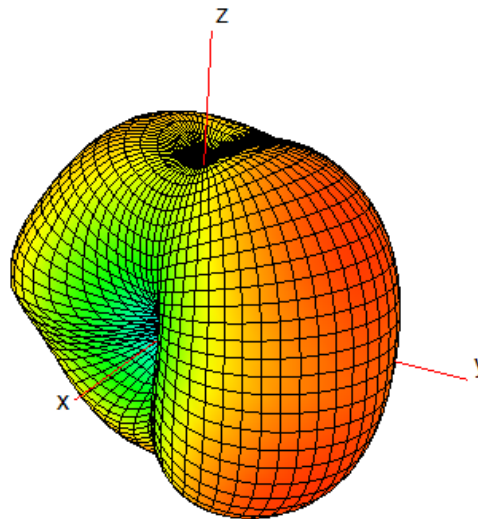

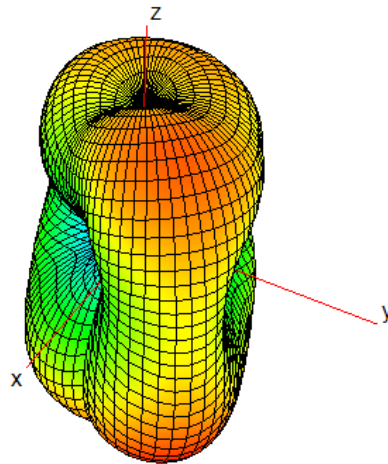

2500MHZ

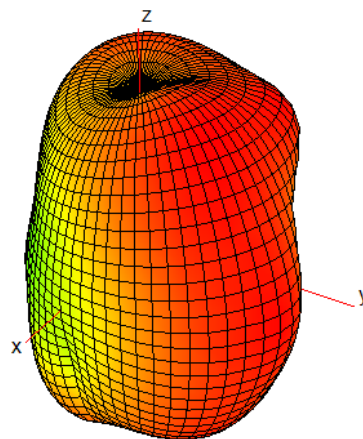

3600MHZ

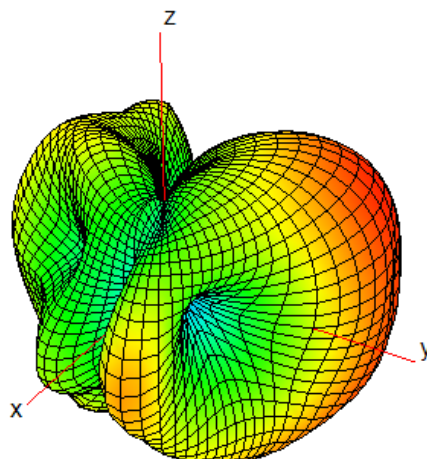

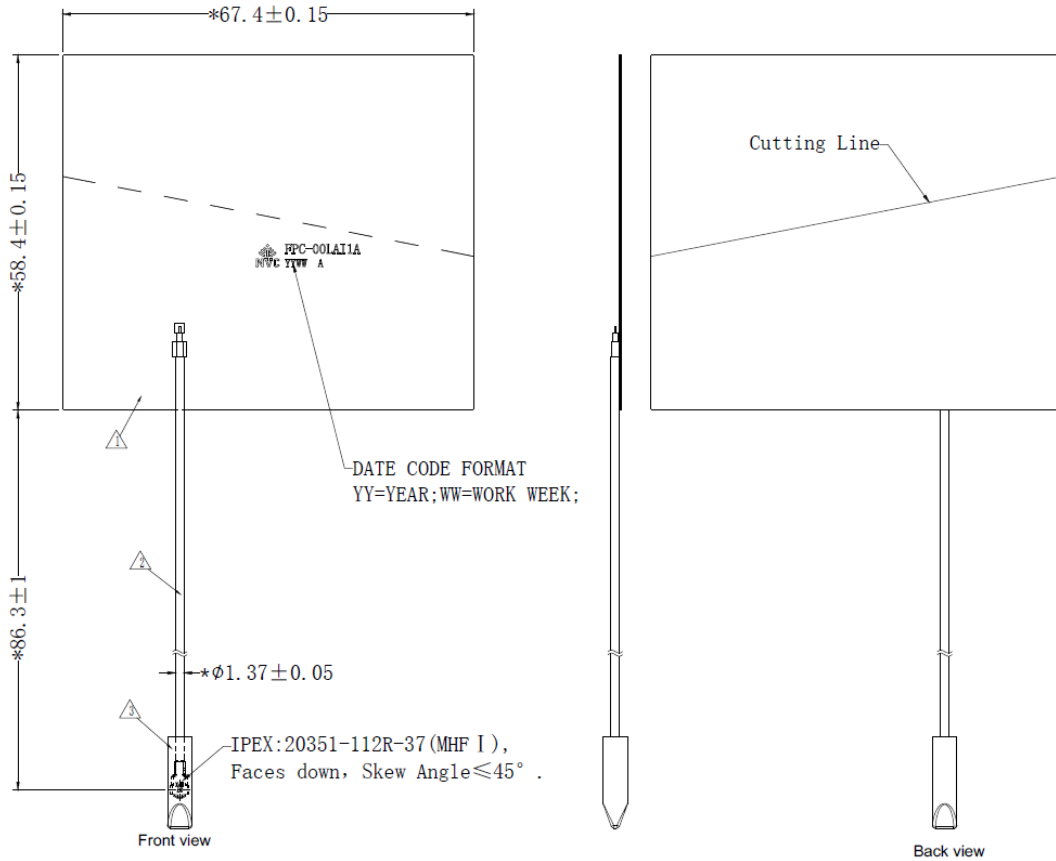

3	66-FPC-00WA10A01	RF plug protector: $\phi 3 * L15$	1
2	41-FPC-00LAI1A01	FPC-00LAI1A-Cable-Black- $\phi 1.37$ -IPEX1	1
1	40-FPC-00LAI1A01	FPC-00LAI1A-FPC-Black-PI	1
ITEM	Part NO.	Description	QTY

Unit: mm

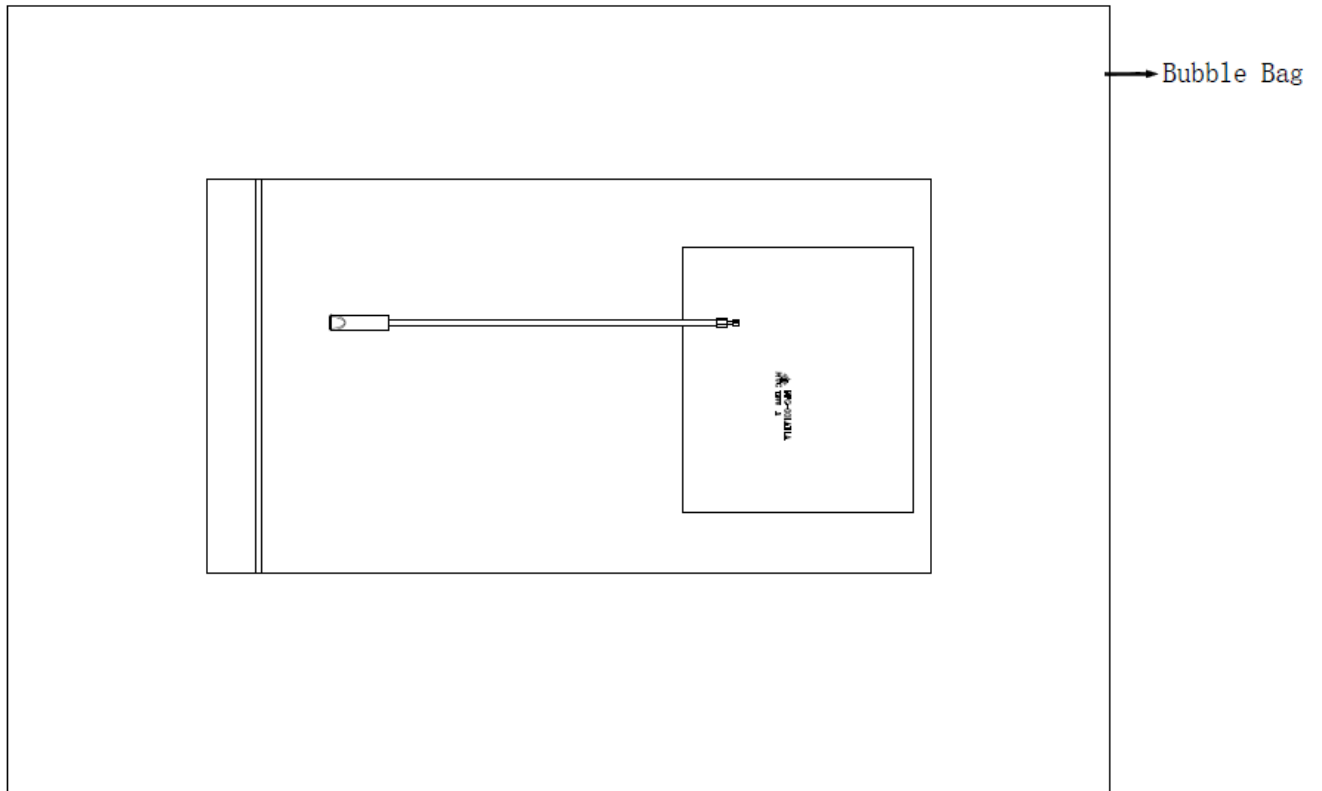
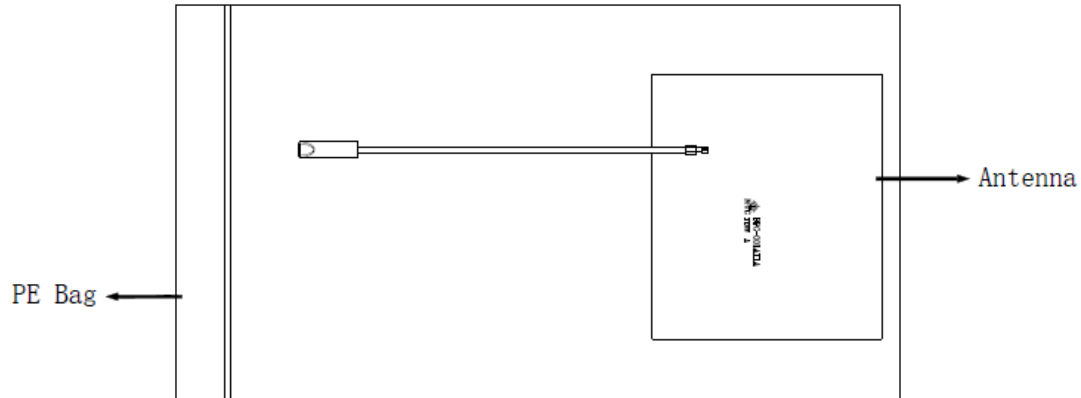

10 pieces per PE Bag

200 pieces per Bubble Bag

2000 pieces per Outer Carton

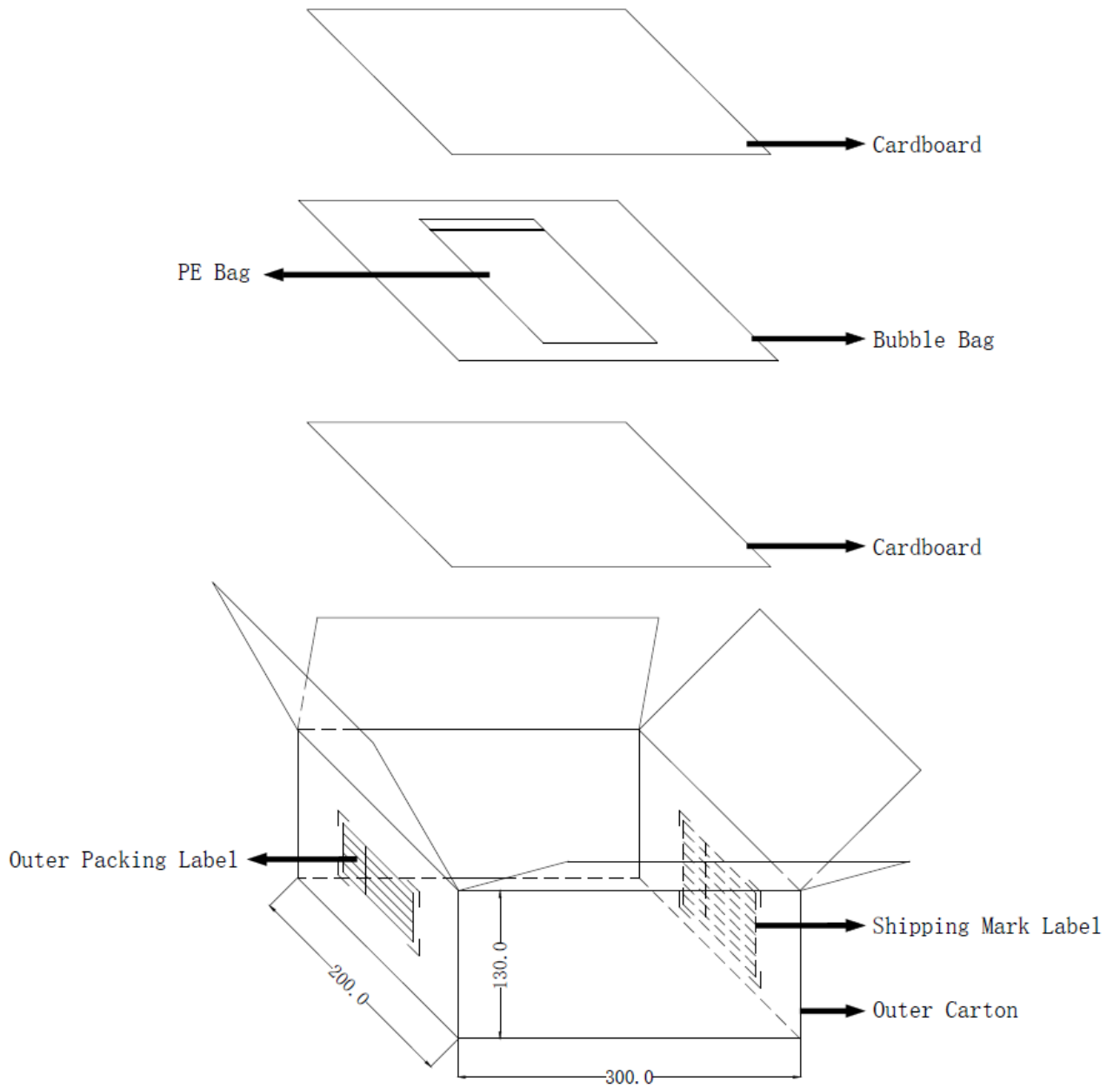



NOVOCOMMS

6. Application Note

Flexible PCB Antenna Series

P/N: FPC-00LAI1A

The antenna can be easily stick on the inner side of the device enclosure, please be aware any metal content part might affect antenna radiation performance. Please keep the metal content part as far as possible to antenna. If your evaluation cannot avoid the metal content part approximate to antenna body. Please contact your local supporting NVC sales, we will provide the best simulation in your application. Also, get the antenna fine tuned with the best performance delivery.